

MOUNTING CLAMPS FOR CABLES AND ELECTRODES

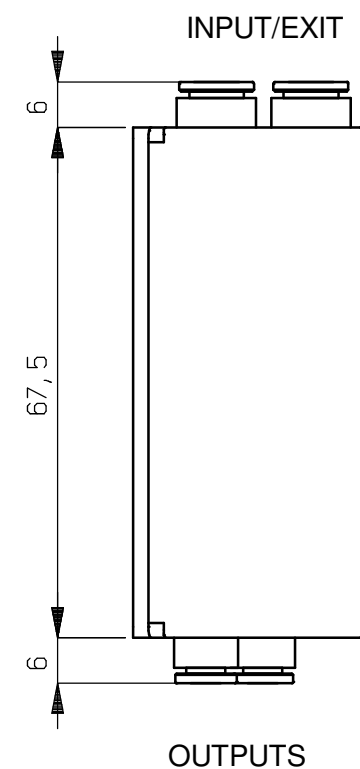

OUTPUTS

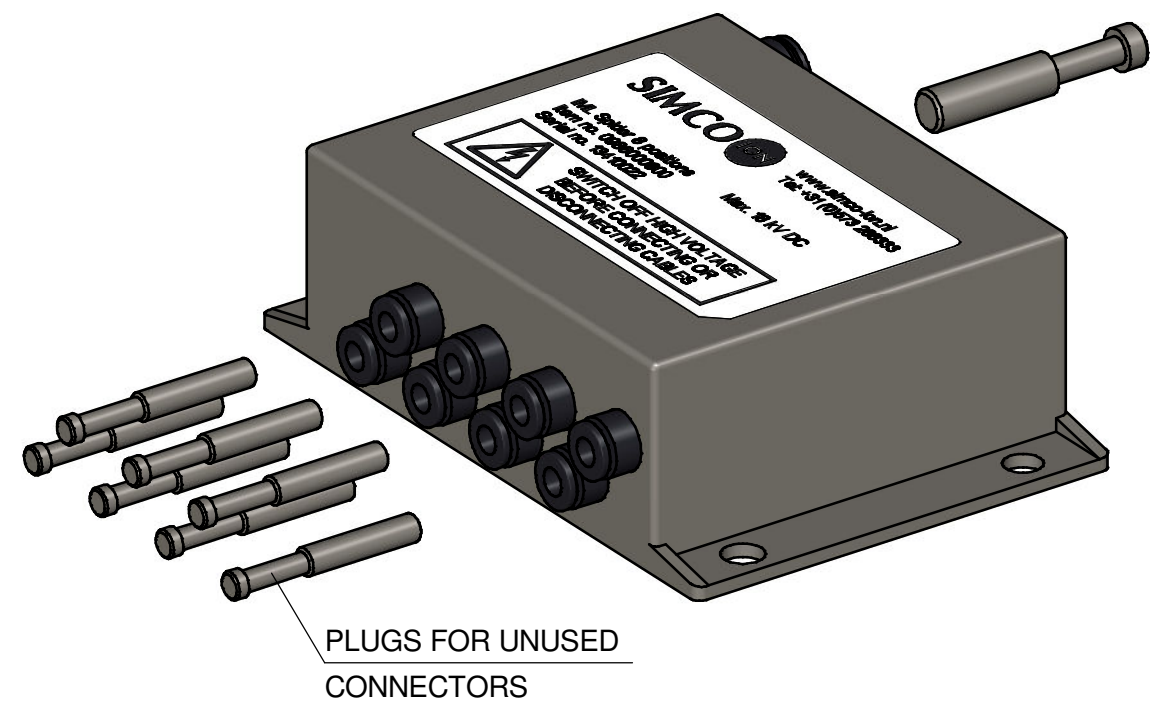
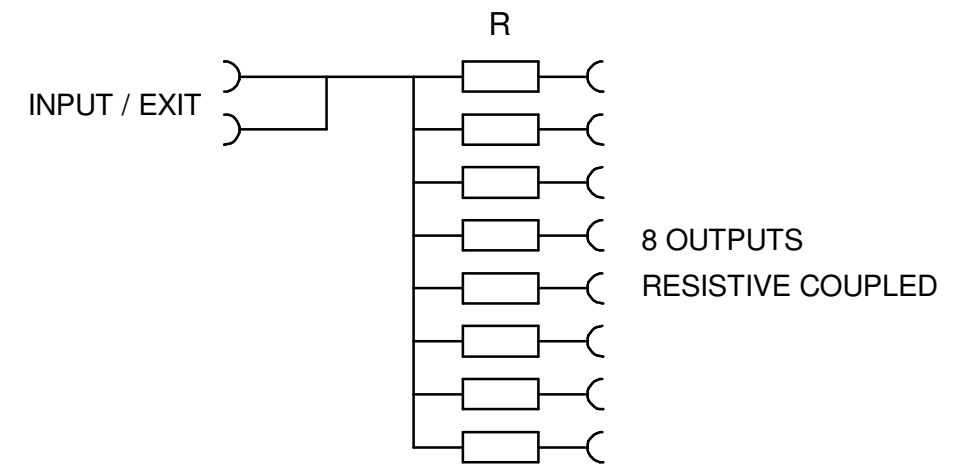

- Only for use with IML Spider components
- Maximum working voltage: 18 kV DC
- Overview IML Spider components: 09860010
- Plugs for unused connections included
- Mounting clamps for cables and electrodes included
- Cover the unused connections with the supplied plugs

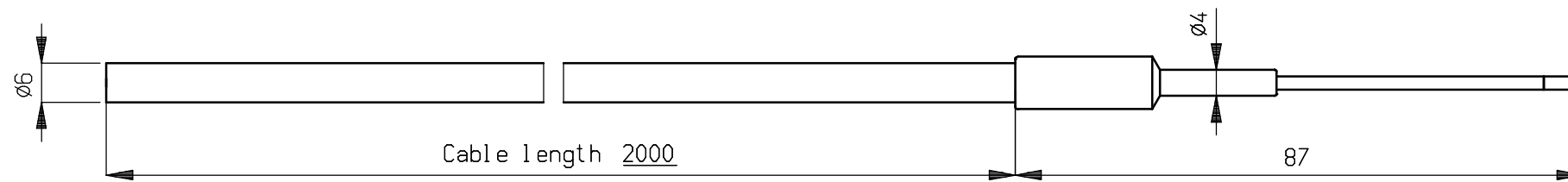

PLUGS FOR UNUSED CONNECTORS

 An ITW Company	Name: IML Spider 8 positions					Drawn: AB	Part no.: 0986000800
	CAD generated NOT updated	Dimensions in mm	Date: 28-2-2013	A3	M: 1:1	ECN-	Check: -
www.simco-ion.nl Tel: +31 (0)573 288333							Dwg. no.: 09860000



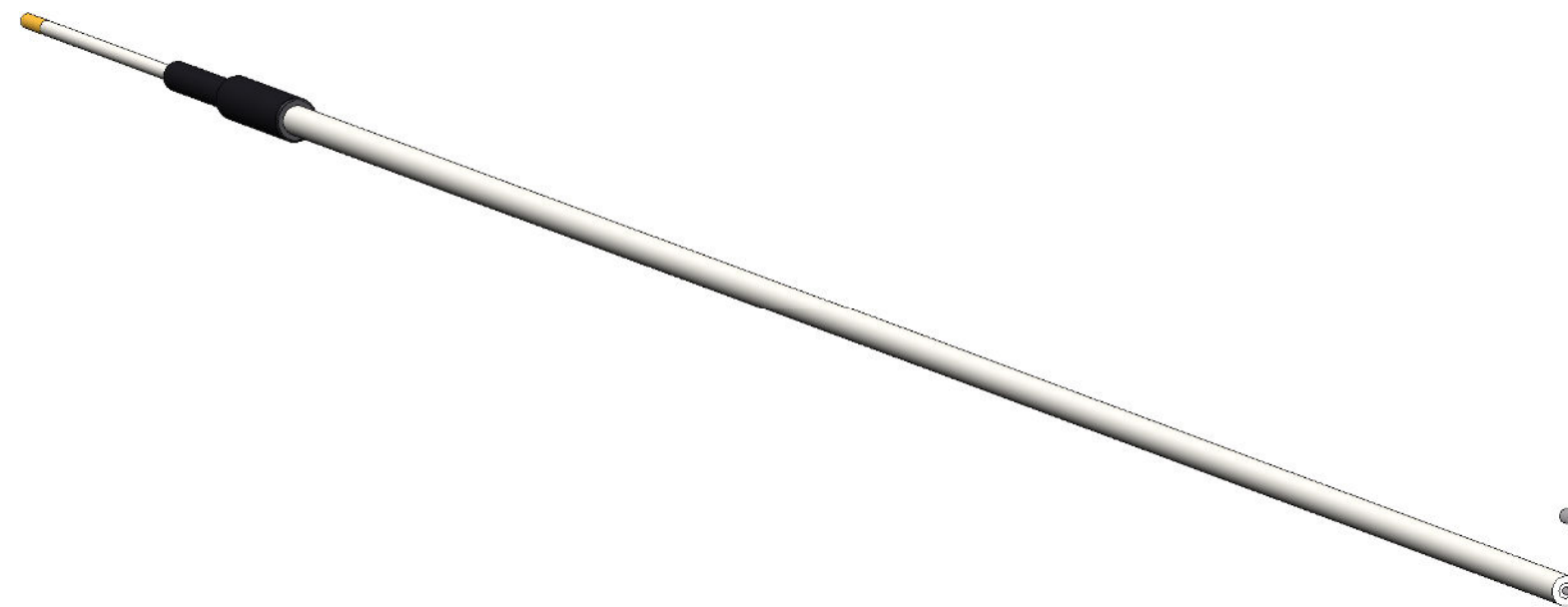
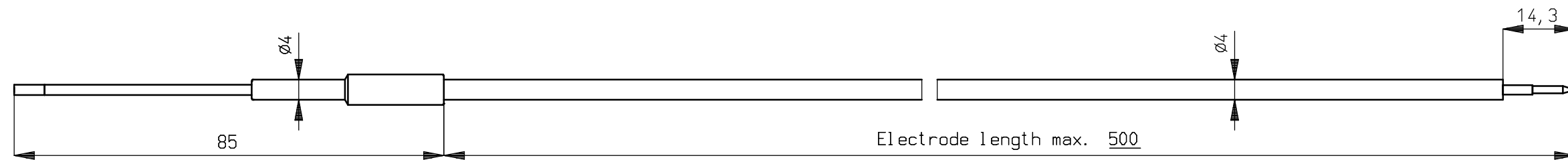

 An ITW Company <small>www.simco-ion.nl Tel: +31 (0)573 288333</small>	Name: IML Spider cable ($\varnothing 4$ mm connector)					Drawn: AB	Part no.: 0986402000
	CAD generated NOT updated	Dimensions in mm	Date: 14-1-2013	A3	M: 1:1	 ECN-	Check: -



Spare pin for IML Spider electrode custom
to be crimped by customer
P/N 9139500050

NOTES

- Customer shortable IML electrode
- Crimping tool required to connect the HV-pin
- Crimping tool: Astro Tool Corp. type M22520/1-01, (sel. no. 6/wire size 16) or equivalent

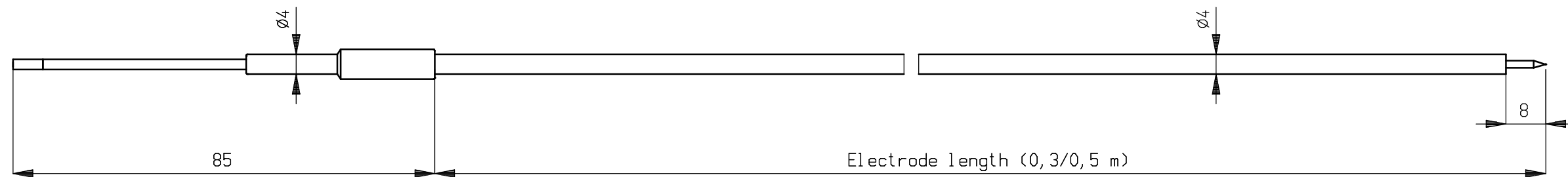

 An ITW Company www.simco-ion.nl Tel: +31 (0)573 288333	Name: IML Spider electrode custom ($\varnothing 4$ mm connector)				Drawn: AB	Part no.: 0986310500
	CAD generated NOT updated	Dimensions in mm	Date: 14-1-2013	A3 M: 1:1	 ECN2014-011	Check: -



Item numbers

0986300300 - Electrode length 0,3 m

0986300500 - Electrode length 0,5 m

 An ITW Company www.simco-ion.nl Tel: +31 (0)573 288333	Name: IML Spider electrode (Ø4 mm connector)				Drawn: AB	Part no.: 098630xx00
	CAD generated NOT updated	Dimensions in mm	Date: 14-1-2013	A3 M: 1:1	 ECN-	Check: -

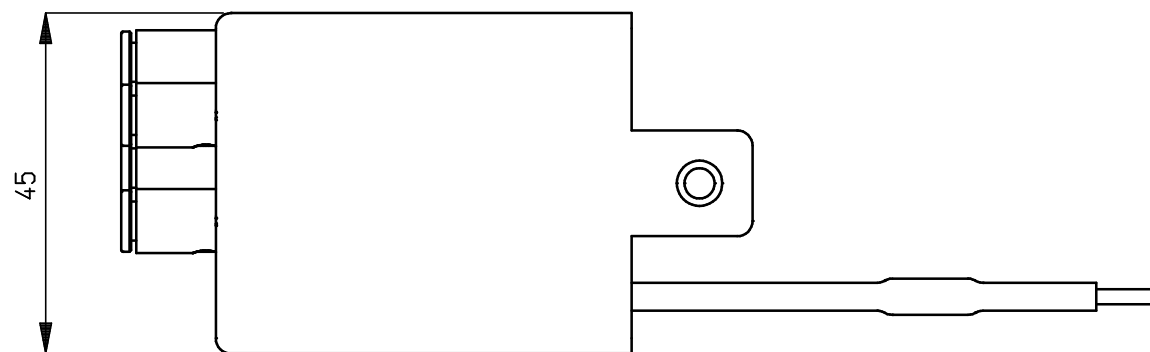
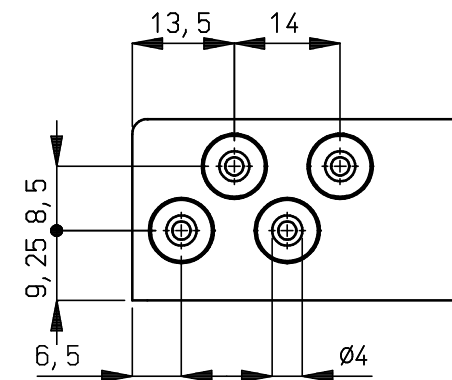
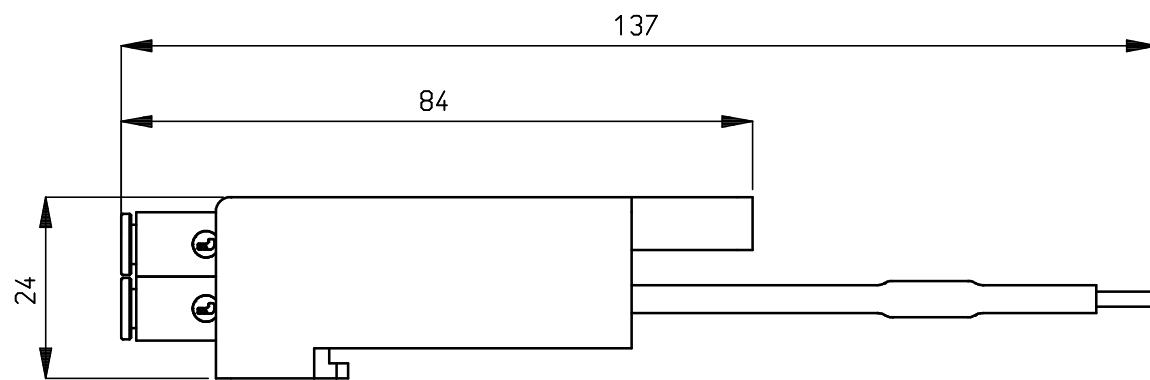

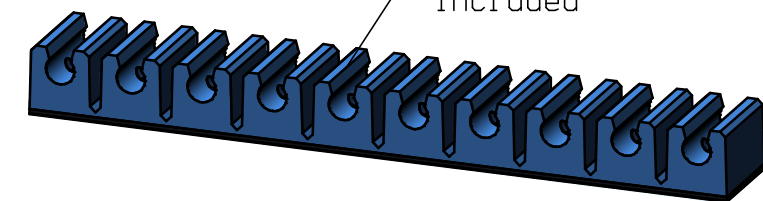

Mounting clamps
for electrodes Ø4 mm
included

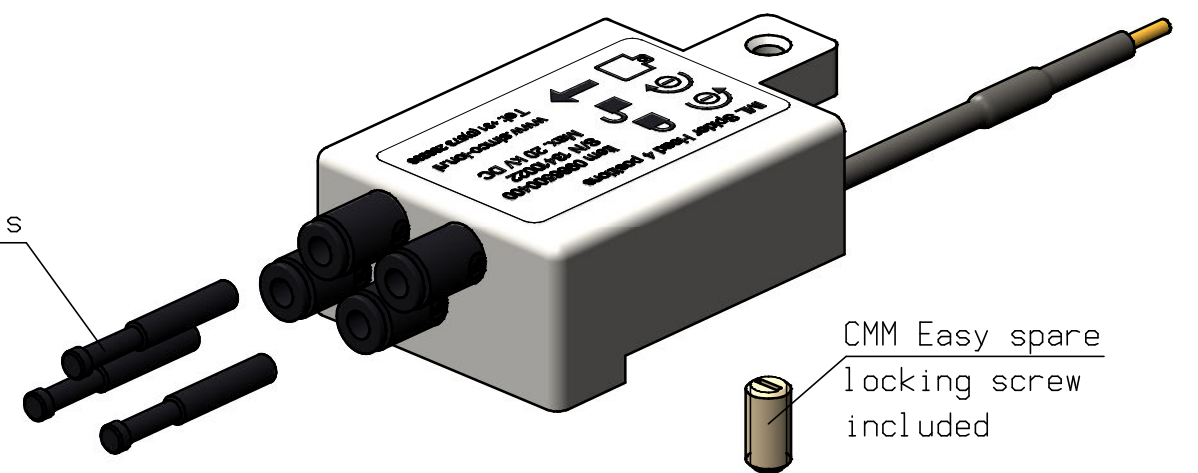

Plugs for unused exits
included



 An ITW Company www.simco-ion.nl Tel: +31 (0)573 288333	Name: IML Spider Head 4 positions						Drawn: AB	Part no.: 0986500400
	CAD generated NOT updated	Dimensions in mm	Date: 14-1-2013	A3	M: 1:1		ECN2017-013	Check: -